

Name: _____
 Straße: _____
 Ort: _____
 Telefon: _____
 Email: _____

Angebot anfordern

Bestellung

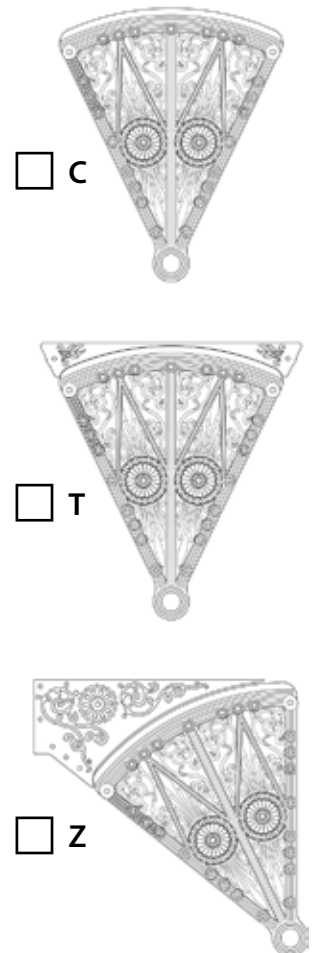
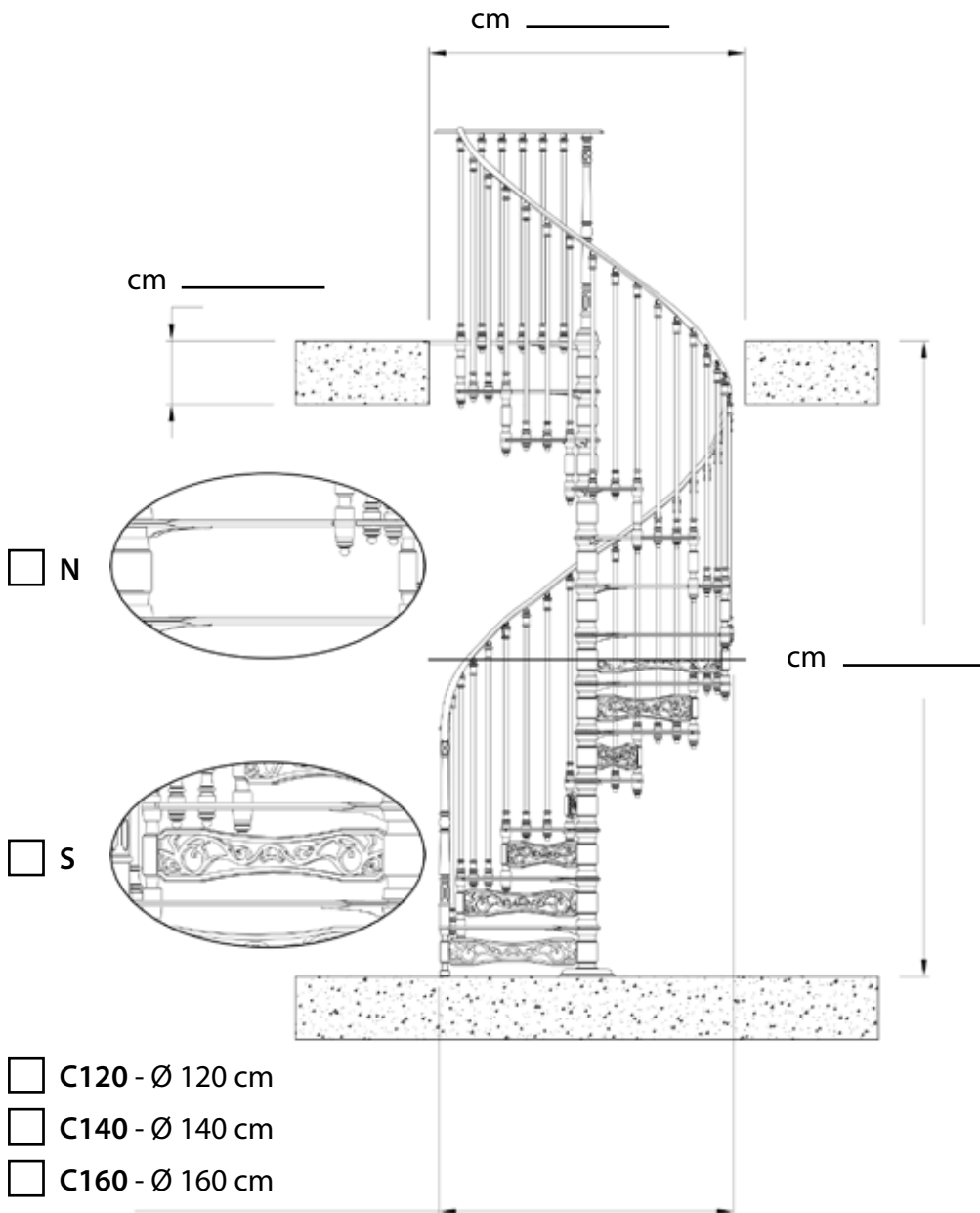

Farbe

Standard

RAL

LED optional

(nur für den Innenbereich geeignet)

Gusseisen-Stufen

Glas-Stufen

Geländerstäbe je Stufe

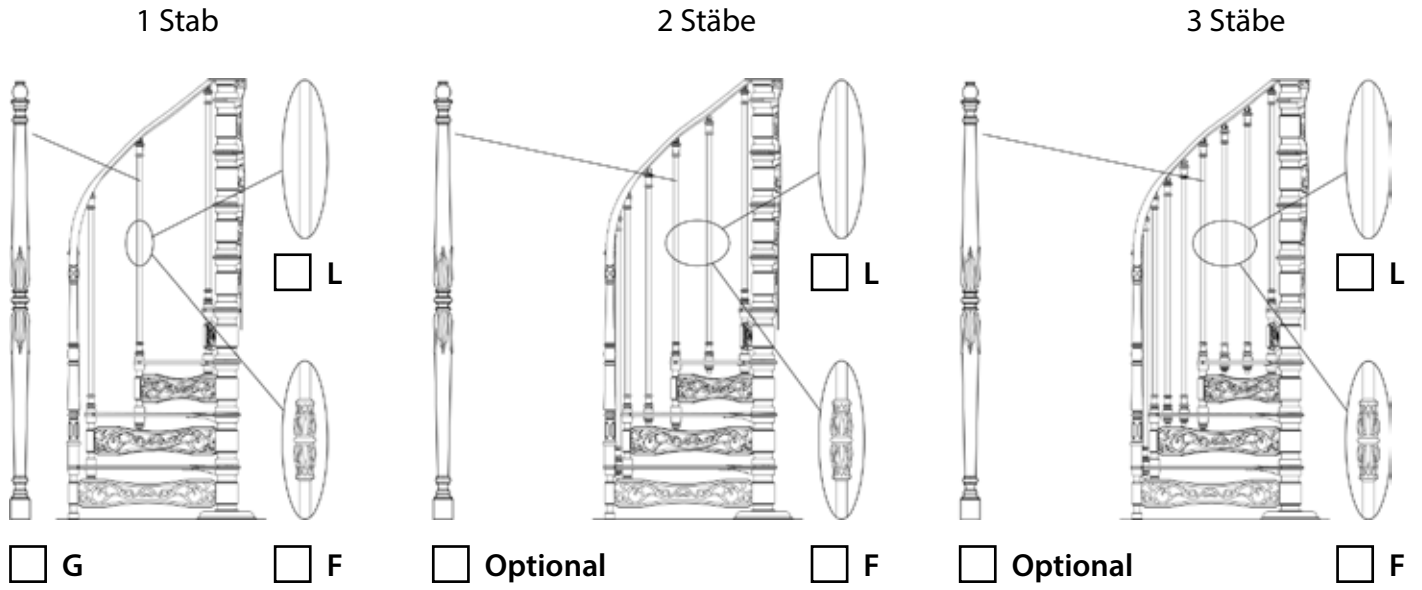

Optionale Geländerelemente je Stufe

Gusseisen

Glas

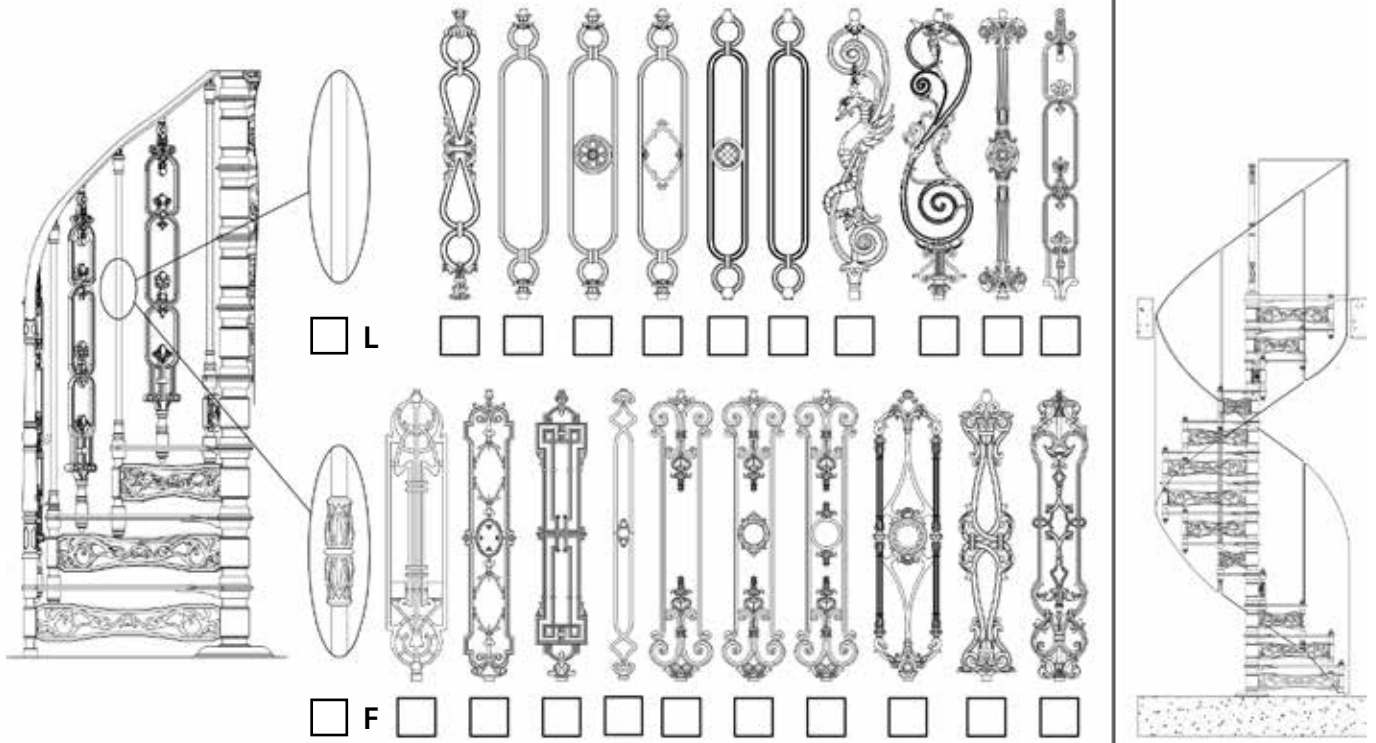

Stufenplan

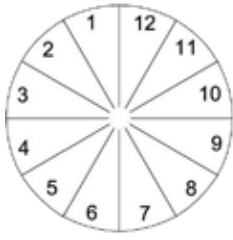

Ø 120 cm

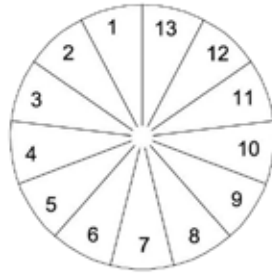

Ø 140 cm

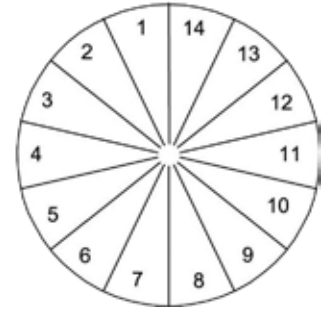

Ø 160 cm

Umrandungsgeländer Austrittsebene

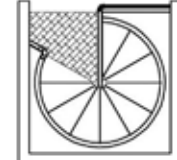
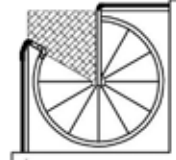
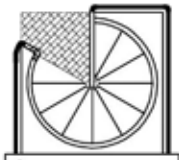
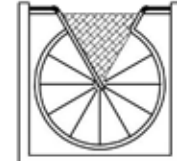
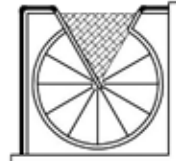
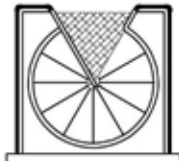
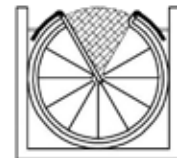
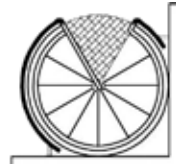
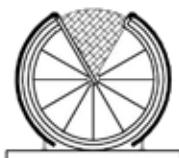

Anmerkungen

Eintrittsebene

Austrittsebene